

ZAXIS180



HYDRAULIC EXCAVATOR

Model Code : ZX180LC-5G / ZX180LCN-5G

Engine Rated Power : 90.2 kW (121 HP)

Operating Weight : ZX180LC-5G : 18 400 - 19 500 kg

ZX180LCN-5G : 18 100 - 19 300 kg

Backhoe Bucket : ISO Heaped : 0.70 - 1.20 m³

ZAXIS Empower your Vision.

A ZAXIS hallmark – industry-leading hydraulic technologies, and performance no other can beat.

New ZAXIS provides reliable solutions: impressive fuel economy, swift front movements, and easy operation. You'll also find Hitachi technological prowess and expertise, such as the optimized hydraulic system and engine.

New ZAXIS features the key benefits of high quality, low fuel consumption, and high durability, all of which serve to ensure low running costs.

New ZAXIS, which is empowered by comprehensive evolution, will realize customers' visions and dreams, and pioneer your colorful future.



Key Benefits for Low Running Costs



Note: The photos in this brochure show excavators with optional equipments such as additional cab roof front lights.

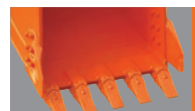

More Production with Less Fuel

Page 4-5

- 4% reduction in fuel consumption
- More fuel reduction in the ECO mode
- Swift front movements with HIOS III hydraulics
- Powerful lifting operation
- Enhanced power boost



No Compromise on Operator Comfort

Page 8-9

- Comfortable operating environment
- Comfort-designed operator seat
- Robust cab
- New, easy-to-use multifunctional monitor

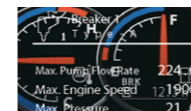

Reliable Solutions, with Various Options

Page 12-13

- Varied jobs, varied options
- Recommended options



Pursuits of Performance and Durability

Page 6-7

- Prestige R&D and quality control
- Durable, reliable engine
- Rock-solid, durable front attachment
- Strengthened undercarriage
- Proven upperstructure



Simplified Maintenance

Page 10-11

- Dust-proof net
- Grouped remote inspection points
- Attractive, robust body
- Low life cycle costs



Hitachi Support Chain

Page 14-15

- Remote fleet management with Global e-Service
- Parts and service



More Production with Less Fuel

4% Reduction in Fuel Consumption

New ZAXIS is a fuel-thrifty excavator that can reduce fuel consumption by 4%*, compared to the conventional ZX180-3 family, thanks to the HIOS III hydraulic system and engine control system, thereby reducing CO2 emissions.

*20%, compared to the ZX200 / ZX200-3G.

More Fuel Reduction in the ECO mode

The ECO mode, a new economical mode, gives high productivity with less fuel and can cut fuel consumption by 26% compared to the PWR mode.



Swift Front Movements with HIOS* III Hydraulics

Operating speed increases with less fuel consumption thanks to the HIOS III hydraulic system, developed by industry-leading hydraulic technologies and a wealth of experience. Actuators work quickly by boom weight, without needing a regenerative circuit and pressure oil.

*Human & Intelligent Operation System

Rapid Arm Roll-in

Arm roll-in speed increases by combined flow from arm and boom cylinders through regenerative valves for productive excavation.

Fast Arm Speed During Boom Lowering

Arm speed increases by boom weight during boom lowering, without needing pressure oil from a pump. That is, arm circuit flow is increased for higher arm speed, allowing for quick loading of a dump truck and positioning of the front.

Powerful Lifting Operation

The Auto Power Lift mode, which automatically surge lifting force by 10% when needed, allows for powerful lifting of buried concrete pipes or sheathing sheets.

Enhanced Power Boost

The Power Boost mode allows the operator to surge 10% more digging force for powerful excavation by pressing its button on the control lever.



Pursuits of Performance and Durability

Prestige R&D and Quality Control

Hitachi has earned praise for technological prowess and product performance around the world. R&D Division has a track record – including excellent design, stress analysis expertise using CAE system, and abundant production data base. What's more, a large-scale durability test field (427 hm²) allows for a series of stringent testing of new machines.

Production Division strives to automatize production processes, including robotic welding, machining, painting, assembling and transferring.



Computer-Aided Engineering

Main pump testing area

Mid-sized excavator assembly line

Main frame welding line

Simulation testing from operator seat



Durable, Reliable Engine

This engine has a track record showing impressive durability at countless tough job sites around the world.

The engine — associated with a rugged design, a direct fuel injection system and an elaborate governor — goes green, and complies with EU Stage II and US EPA Tier 2 emissions regulations.

The cooling system well keeps the engine cool. The cooling fan is improved to cool the engine more efficiently.

The ample-capacity intercooler and turbocharger help yield a whopping 90.2 kW (121 HP) output for higher production in shorter job schedule.



Rock-Solid, Durable Front Attachment

The boom top and boom foot brackets frame side are reinforced with thickened high-tensile steel, which incorporate steel bushings to enhance durability. Arm cylinder and boom cylinders (rod extend ends) cushion shocks at stroke ends to cut noise and extend service life.

Joint pins at the front attachment are tightly fit to reduce jolt and sound. The arm-bucket joint is protected by WC thermal spraying on its contact surfaces to reduce wear and jolt. New-type HN bushings, utilized on joint pins, retain grease inside for longer greasing intervals. A reinforced resin thrust plate, provided at front attachment joints, helps reduce wearing noise.

Strengthened Undercarriage

The X-beam frame is made monolithically with fewer welds for higher rigidity and durability. Track adjusters absorb impacts to crawlers. Front idlers and adjuster cylinders are integrated to increase durability. Idler brackets and travel motor brackets are both thickened for added durability.

Proven Upperstructure

The upperstructure frame is reinforced with the proven D-section skirt to increase rigidity against damage by obstacles. The door catch is improved to shut the door tightly, reducing door rattling.



HN bushing

Reinforced resin thrust plates

WC thermal spraying

X-beam frame

Track adjuster

Boom foot bracket

No Compromise on Operator Comfort

Comfortable Operating Environment

You'll feel comfortable and confident, with plenty of leg space and excellent visibility when operating the cab. The new compact console gives more leg space. The new door pillar is shifted rearward by 70 mm to widen an entry space for easy access. A new LED room light, interlocked with the door, turns on when the door opens. The front window is easily removed and stored overhead using slide rails. The overhead window is openable for ventilation. Ample air conditioner vents are located strategically for uniform air circulation inside the cab. The control panel and control levers are arranged within easy reach of the operator. AM/FM radio and AUX port (optional) for a mobile music player are available for a long work day with less fatigue. All these designs focus on operator comfort.

Comfort-Designed Operator Seat

The luxury cloth seat is fitted with a headrest and arm rests for operator comfort. The seat can be adjusted in multiple ways, sliding and reclining, to suit operator's size and preferences. The seat can slide rearward by 40 mm more for added leg space. The air suspension seat with a heat pad is optional.

Robust Cab

The robust cab, meeting the OPG (Top Guard Level 1), protects the operator from falling objects. The pilot control shut-off lever is provided with a neutral engine start system that permits engine starting only when the pilot control shut-off lever is in Lock position.



Control panel

Large storage space



New, Easy-to-Use Multifunction Monitor

The new multi-language, multifunction monitoring system comprises a 7-inch high-resolution color monitor and a multifunction controller. The monitor allows the operator to check varying operating variables: coolant temperature, fuel level, work mode, full-auto air conditioner, AM/FM radio, rear view monitor camera (optional), maintenance support, and attachment flow adjustment. Menu items can be selected and adjusted by a multifunction controller on the control panel. A new rear view monitor camera always displays the view behind the machine.



Simplified Maintenance



Dust-Proof Net

A dust-proof net, provided at the front of radiator, can be easily removed and cleaned with compressed air.

Attractive, Robust Body

Side frame tops of the undercarriage are sloped to let muck slide away. Track adjuster greasing ports are repositioned for easier lubrication, and well protected from muck packing.

Grouped Remote Inspection Points

Service points are concentrated inside left and right covers that are readily accessible from ground level for convenient servicing and inspection, including water draining from the fuel tank, replenishment of coolant, and replacement of filters. The fuel tank is anti-corrosion coated on its inside, and has a large cleaning port at the bottom. These wise designs effectively keep fuel clean, and ease servicing. Handrails are provided at convenient locations for easy riding on the upperstructure. Plenty slip-resistant plates are located for safe maintenance.



Grouped remote filters and inspection points



Air cleaner double filters



Fuel tank water drainage cock

Low Life Cycle Costs

Service intervals are long enough to slash maintenance costs.



Lubricant Consumables

Note: Periodic inspection is required to check oil contamination and such.

Reliable Solutions, with Various Options

Easy-to-Use Attachments

The operator can change over valves, adjust extra circuit flow, and check settings from the multifunctional monitor next to the operator seat. What's more, 11 jobs, including flow rate setting, can easily be selected by their identified names.

Easy-to-Operate Breaker

When using a breaker that requires frequent change of hydraulic oil and filters, an extra hour meter on the multifunctional monitor displays operating hours of the breaker, suggesting adequate replacement timing of oil and filters. The Breaker Alarm (optional) displays an alert mark on the monitor screen, and sounds when the breaker works continuously over one minute.

Varied Jobs, Varied Options

Lower cab front guard is provided for protection against debris during demolition and breaker operation. High-performance filters are available and are recommended for using breaker frequently.

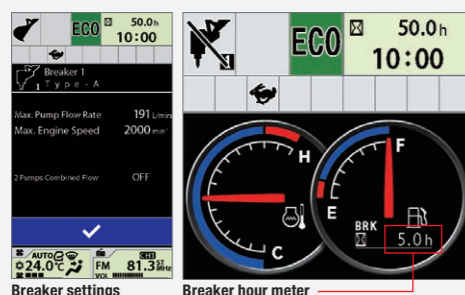

Recommended Options



Hitachi Support Chain

Hitachi Support Chain is a full customer support system offered after buying a Hitachi machine.

Remote Fleet Management with Global e-Service

Easy Access to On-Site Machines through the Internet

This on-line fleet management system allows you to access each on-site machine from a PC in your office. You can get its operating information and location to increase productivity of the fleet and reduce downtime. Operating data and log are sent to a Hitachi server for processing, and then to customer and dealers around the world. This system is available 24 hours a day, all the year around.

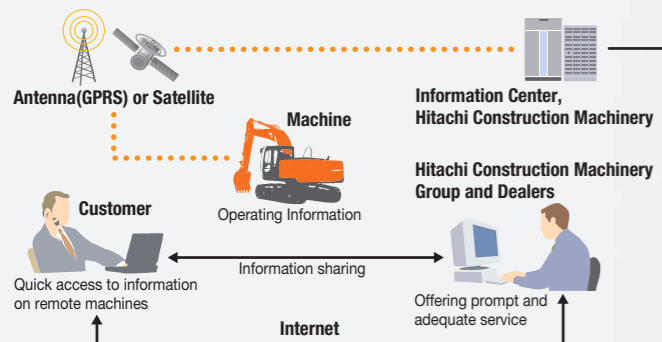

Note: In Some Regions, Global e-Service Is Not Available by Local Regulations.

Main Features of Global e-Service

Functions

Global e-Service provides easy access to a machine on site, conveying operating information and log, including daily operating hours, fuel level, temperatures, pressures, and likes.

Maintenance

Maintenance data and log are displayed on a easy-to-read monitor screen, suggesting recommended maintenance for efficient fleet management.

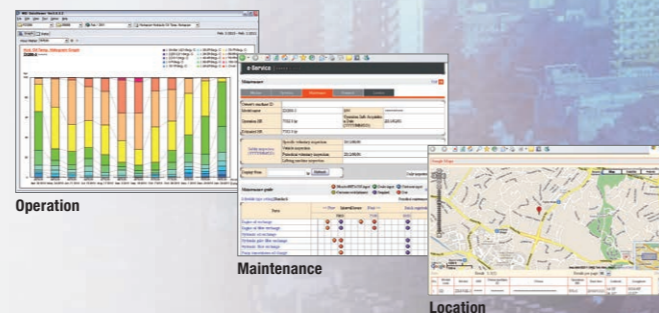

Parts and Service

Hitachi full customer support is available every area on the globe for full customer satisfaction through Hitachi local dealers.

Parts

Hitachi Global Online Network, a parts supply system, is linked with Japan Parts Center, overseas depots and over 150 dealers abroad to deliver on-line parts information, including in-stock parts, order receptions, shipments and delivery period of over one million parts and components.

Genuine Hitachi Parts

Genuine Hitachi parts, meeting Hitachi stringent quality standards, are guaranteed according to Hitachi warranty standards. The use of genuine Hitachi parts, including engine, fuel, hydraulic oil and filters, may slash running costs, and extend machine life.

Ground Engaging Tools (GETs)

Hitachi provides an array of Hitachi Ground Engaging Tools developed and built for a variety of applications.

Using high-quality, well-maintained GETs will help you get customers' trust.

Note: Some dealers do not handle Hitachi GETs.

Remanufactured Components

Hitachi components are remanufactured according to the stringent remanufacturing standards at factories around the world. They have high quality equivalent to new ones, and backed up by Hitachi warranty system.

Note: Some dealers do not handle Hitachi Remanufactured Components.

Service

Extended Warranty — HELP

Hitachi Standard Warranty System is available on all new Hitachi machines. In addition, Hitachi offers Hitachi Extended Life Programs (HELPS) to suit customer expectations –

protecting machines under tough operating conditions, avoiding unexpected downtime, and reducing repair costs.

Note: Warranty conditions vary by equipment.

Diagnostic Tools — Maintenance Pro

Electronic control system needs quick on-site solutions, apart from mechanical repairs. Hitachi's Maintenance Pro can diagnose machine failures in a short time by plugging a PC into a failed machine.

Technical Training

On-site servicing matters despite locations to keep the machine at peak performance and reduce downtime. Technical Training Center (TTC), located in Japan, educates and trains service technicians and service support personnel coming from Hitachi dealers and factories on the globe according to the international training programs.

SPECIFICATIONS

ENGINE

Model	Isuzu AA-4BG1T
Type	4-cycle water-cooled, direct injection
Aspiration	Turbocharged, intercooled
No. of cylinders	4
Rated power	
ISO 9249, net	90.2 kW (121 HP) at 2 200 min ⁻¹ (rpm)
SAE J1349, net	90.2 kW (121 HP) at 2 200 min ⁻¹ (rpm)
Maximum torque	458 Nm (46.7 kgfm) at 1 800 min ⁻¹ (rpm)
Piston displacement ..	4.329 L
Bore and stroke	105 mm x 125 mm
Batteries	2 x 12 V / 55 Ah

HYDRAULIC SYSTEM

Hydraulic Pumps

Main pumps	2 variable displacement axial piston pumps
Maximum oil flow ..	2 x 191 L/min
Pilot pump	1 gear pump
Maximum oil flow ..	33.6 L/min

Hydraulic Motors

Travel	2 variable displacement axial piston motors
Swing	1 axial piston motor

Relief Valve Settings

Implement circuit	34.3 MPa (350 kgf/cm ²)
Swing circuit	32.4 MPa (330 kgf/cm ²)
Travel circuit	34.3 MPa (350 kgf/cm ²)
Pilot circuit	3.9 MPa (40 kgf/cm ²)
Power boost	38.0 MPa (388 kgf/cm ²)

Hydraulic Cylinders

	Quantity	Bore	Rod diameter
Boom	2	120 mm	85 mm
Arm	1	125 mm	90 mm
Bucket	1	105 mm	75 mm

UPPERSTRUCTURE

Revolving Frame

D-section frame skirt for resistance to deformation.

Swing Device

Swash plate piston motor with planetary reduction gear is bathed in oil. Swing circle is single-row. Swing parking brake is spring-set/hydraulic-released disc type.

Swing speed	14.4 min ⁻¹ (rpm)
Swing torque	53.3 kNm (5 400 kgfm)

Operator's Cab

Independent spacious cab, 1 005 mm wide by 1 675 mm high, conforming to ISO* Standards.

* International Organization for Standardization

UNDERCARRIAGE

Tracks

Heat-treated connecting pins with dirt seals. Hydraulic (grease) track adjusters with shock-absorbing recoil springs.

Numbers of Rollers and Shoes on Each Side

Upper rollers	2
Lower rollers	7
Track shoes	46
Track guard	1

Travel Device

Each track driven by 2-speed axial piston motor. Parking brake is spring-set/hydraulic-released disc type. Automatic transmission system: High-Low.

Travel speeds	High : 0 to 5.3 km/h
	Low : 0 to 3.4 km/h

Maximum traction force .. 169 kN (17 300 kgf)

Gradeability

SERVICE REFILL CAPACITIES

Fuel tank	320.0 L
Engine coolant	19.2 L
Engine oil	15.8 L
Swing device	6.2 L
Travel device (each side)	6.8 L
Hydraulic system	210.0 L
Hydraulic oil tank	125.0 L

WEIGHTS AND GROUND PRESSURE

Operating weight and Ground pressure

Shoe type	Shoe width	Arm length	ZX180LC-5G ^{*1}		ZX180LCN-5G ^{*1}	
			kg	kPa(kgf/cm ²)	kg	kPa(kgf/cm ²)
Triple grouser	500 mm	2.26 m	—	—	18 100	49 (0.50)
		2.71 m	—	—	18 100	49 (0.50)
		3.21 m	—	—	18 200	49 (0.50)
	600 mm	2.26 m	18 400	41 (0.42)	18 300	41 (0.42)
		2.71 m	18 400	41 (0.42)	18 400	41 (0.42)
		3.21 m	18 500	41 (0.42)	18 400	41 (0.42)
	700 mm	2.26 m	18 800	36 (0.37)	18 700	36 (0.37)
		2.71 m	18 800	36 (0.37)	18 700	36 (0.37)
		3.21 m	18 900	36 (0.37)	18 800	36 (0.37)
800 mm	2.26 m	19 000	32 (0.33)	—	—	
	2.71 m	19 100	32 (0.33)	—	—	
	3.21 m	19 200	32 (0.33)	—	—	
Triangular	760 mm	2.26 m	19 400	34 (0.35)	—	—
		2.71 m	19 500	34 (0.35)	—	—
		3.21 m	19 500	34 (0.35)	—	—
Flat	600 mm	2.26 m	19 200	43 (0.44)	19 100	43 (0.44)
		2.71 m	19 300	43 (0.44)	19 200	43 (0.44)
		3.21 m	19 400	43 (0.44)	19 300	43 (0.44)

*1 :Including 0.70 m³ (ISO heaped) bucket weight (600 kg) and counterweight (3 900kg).

WEIGHT: BASIC MACHINE and COMPONENTS

Basic Machine Weight and Overall width

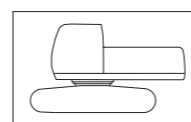

Excluding front-end attachment, fuel, hydraulic oil, coolant, etc., and including counterweight.

ZX180LC-5G

Shoe width	Weight	Overall width
600 mm	14 600 kg	2 800 mm
700 mm	14 900 kg	2 900 mm
800 mm	15 200 kg	3 000 mm

ZX180LCN-5G

Shoe width	Weight	Overall width
500 mm	14 200 kg	2 500 mm
600 mm	14 500 kg	2 590 mm
700 mm	14 900 kg	2 690 mm

Component weights

	ZX180LC-5G / ZX180LCN-5G
Counterweight	3 900 kg
Boom (with boom and arm cylinder)	1 860 kg
2.26 m arm (with bucket cylinder)	820 kg
2.71 m arm (with bucket cylinder)	880 kg
3.21 m arm (with bucket cylinder)	950 kg
0.70 m ³ bucket	600 kg

SPECIFICATIONS

BUCKET AND ARM DIGGING FORCES

Arm length	2.26 m	2.71 m	3.21 m
Bucket digging force* ISO	127 kN (13 000 kgf)	127 kN (13 000 kgf)	127 kN (13 000 kgf)
Bucket digging force* SAE : PCSA	112 kN (11 400 kgf)	112 kN (11 400 kgf)	112 kN (11 400 kgf)
Arm crowd force* ISO	108 kN (11 100 kgf)	95 kN (9 700 kgf)	84 kN (8 600 kgf)
Arm crowd force* SAE : PCSA	104 kN (10 600 kgf)	91 kN (9 300 kgf)	81 kN (8 300 kgf)

* At power boost

BACKHOE ATTACHMENTS

Boom and arms are of welded, box-section design. 5.50 m boom, and 2.26 m, 2.71 m and 3.21 m arms are available. Bucket is of welded steel structure. Side clearance adjust mechanism provided on the bucket joint bracket.

Buckets

Capacity	Width		No. Of teeth	Weight	Recommendation		
	Without side cutters	With side cutters			ZX180LC-5G / ZX180LCN-5G		
ISO heaped					2.26 m arm	2.71 m arm	3.21 m arm
0.70 m ³	900 mm	1 010 mm	4	600 kg	⊙	⊙	○
0.80 m ³	1 030 mm	1 140 mm	5	660 kg	⊙	○	□
0.91 m ³	1 150 mm	1 260 mm	5	700 kg	○	□	—
1.10 m ³	1 330 mm	1 440 mm	6	770 kg	○	—	—
1.20 m ³	1 450 mm	—	6	690 kg	□	—	—
*1 0.70 m ³	900 mm	1 010 mm	5	700 kg	⊙	⊙	○
*1 0.80 m ³	1 030 mm	1 140 mm	5	750 kg	⊙	⊙	○
*1 0.91 m ³	1 150 mm	1 260 mm	5	800 kg	○	○	○
*2 0.60 m ³	800 mm	—	3	950 kg	●	—	—
One-point ripper			1	540 kg	●	—	—
Slope-finishing blade : Width 1 100 mm, length 1 800 mm			—	590 kg	◇	◇	◇
V shape bucket			3	530 kg	○	○	○

*1 Reinforced bucket

*2 Ripper bucket

- ⊙ Suitable for materials with density of 2 000 kg/m³ or less
- Suitable for materials with density of 1 600 kg/m³ or less
- Suitable for materials with density of 1 100 kg/m³ or less
- Heavy-duty service
- ◇ Slope-finishing service
- Not applicable

WORKING RANGES

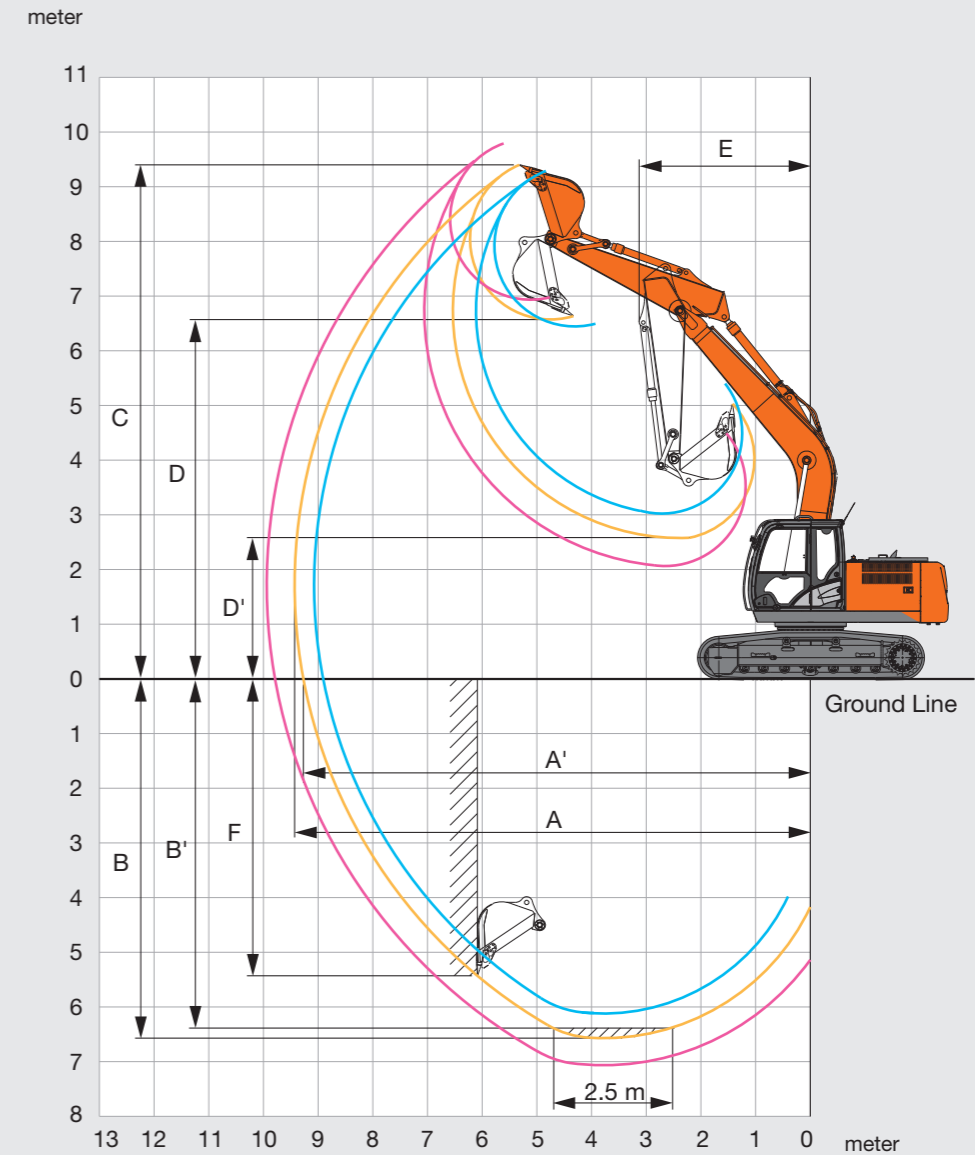

Arm length	2.26 m	2.71 m	3.21 m
A Max. digging reach	9 070	9 430	9 940
A' Max. digging reach (on ground)	8 910	9 270	9 790
B Max. digging depth	6 120	6 570	7 060
B' Max. digging depth for 2.5 m level	5 850	6 320	6 860
C Max. cutting height	9 290	9 400	9 790
D Max. dumping height	6 450	6 570	6 930
D' Min. dumping height	3 020	2 550	2 060
E Min. swing radius	3 140	3 130	3 120
F Max. vertical wall digging depth	5 090	5 430	6 140

Excluding track shoe lug

Unit: mm

SPECIFICATIONS

DIMENSIONS

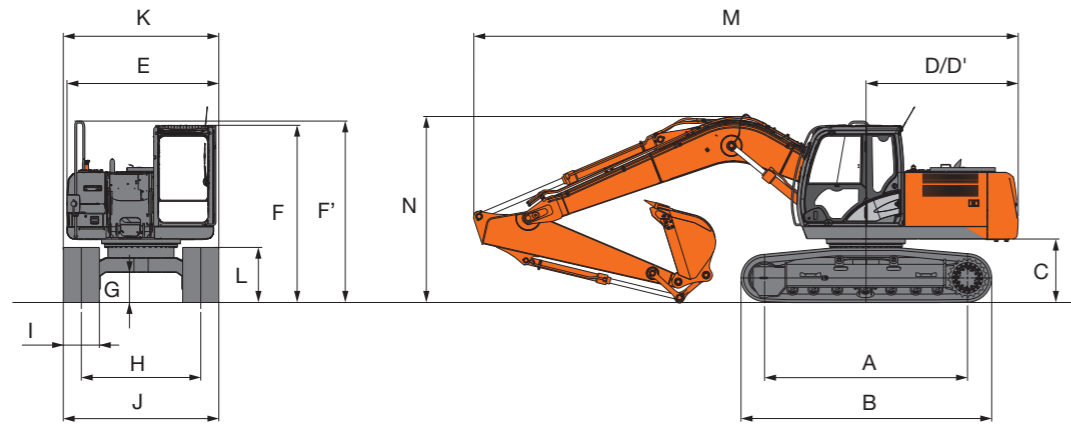

Unit: mm

	ZX180LC-5G	ZX180LCN-5G
A Distance between tumbler	3 370	3 370
B Undercarriage length	4 170	4 170
* C Counterweight clearance	1 030	1 030
D Rear-end swing radius	2 550	2 550
D' Rear-end length	2 530	2 530
E Overall width of upperstructure	2 480	2 480
F Overall height of cab	2 950	2 950
F' Overall height of upperstructure	3 010	3 010
* G Min. ground clearance	450	450
H Track gauge	2 200	1 990
I Track shoe width	G 600	G 500
J Undercarriage width	2 800	2 490
K Overall width	2 800	2 500
L Track height with triple grouser shoes	920	920
M Overall length		
With 2.26 m arm	9 070	9 070
With 2.71 m arm	9 050	9 050
With 3.21 m arm	9 040	9 040
* N Overall height of boom		
With 2.26 m arm	3 110	3 110
With 2.71 m arm	3 080	3 080
With 3.21 m arm	3 410	3 410

* Excluding track shoe lug G: Triple grouser shoe

LIFTING CAPACITIES (Without Bucket)

- Notes: 1. Ratings are based on ISO 10567.
 2. Lifting capacity does not exceed 75% of tipping load with the machine on firm, level ground or 87% full hydraulic capacity.
 3. The load point is the center-line of the bucket pivot mounting pin on the arm.
 4. *Indicates load limited by hydraulic capacity.
 5. 0 m = Ground.

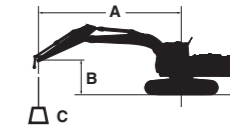

A: Load radius
 B: Load point height
 C: Lifting capacity

For lifting capacities, subtract bucket and quick hitch weight from lifting capacities without bucket.

ZX180LC-5G

Rating over-front Rating over-side or 360 degrees Unit : kg

Conditions	Load point height m	Load radius										At max. reach				
		1.5 m		3.0 m		4.5 m		6.0 m		7.5 m						
		Rating over-front	Rating over-side or 360 degrees	Rating over-front	Rating over-side or 360 degrees	Rating over-front	Rating over-side or 360 degrees	Rating over-front	Rating over-side or 360 degrees	Rating over-front	Rating over-side or 360 degrees	meter				
Boom 5.50 m Arm 2.26 m counterweight 3 900 kg shoe 600 mm	6.0							*5 020	4 120					*4 460	3 830	6.26
	4.5			*7 800	*7 800	*5 980	*5 980	*5 300	4 030					*4 370	3 110	7.07
	3.0					*7 650	5 830	5 940	3 860					4 220	2 770	7.50
	1.5					8 930	5 460	5 750	3 690	4 150	2 700			4 070	2 650	7.60
	0 (Ground)					8 730	5 290	5 630	3 580					4 170	2 710	7.40
	-1.5			*8 960	*8 960	8 700	5 270	5 590	3 550					4 630	2 980	6.88
	-3.0			*12 530	10 150	8 800	5 350							5 780	3 690	5.93
	-4.5			*9 380	*9 380									*6 740	6 040	4.28
Boom 5.50 m Arm 2.71 m counterweight 3 900 kg shoe 600 mm	6.0							*4 510	4 170					*3 410	*3 410	6.69
	4.5					*5 370	*5 370	*4 900	4 070					*3 370	2 870	7.45
	3.0					*7 060	5 920	*5 650	3 890	4 230	2 780			*3 490	2 580	7.86
	1.5					*8 720	5 510	5 760	3 700	4 140	2 690			*3 770	2 470	7.96
	0 (Ground)			*4 890	*4 890	8 720	5 280	5 610	3 560	4 070	2 630			3 870	2 500	7.77
	-1.5	*5 200	*5 200	*8 820	*8 820	8 640	5 210	5 540	3 500					4 230	2 720	7.27
	-3.0	*9 340	*9 340	*13 290	9 980	8 700	5 260	5 590	3 540					5 130	3 280	6.38
	-4.5			*10 670	10 310	*7 440	5 470							*6 680	4 870	4.90
Boom 5.50 m Arm 3.21 m counterweight 3 900 kg shoe 600 mm	6.0							*3 990	*3 990					*2 800	*2 800	7.29
	4.5					*5 370	*5 370	*4 440	4 120	*3 870	2 880			*2 750	2 570	7.99
	3.0					*7 060	5 920	*5 650	3 890	4 230	2 780			*2 830	2 330	8.37
	1.5					*8 720	5 510	5 790	3 720	4 140	2 690			*3 010	2 240	8.47
	0 (Ground)			*5 230	*5 230	8 740	5 290	5 610	3 560	4 050	2 610			*3 360	2 260	8.29
	-1.5	*4 510	*4 510	*7 970	*7 970	8 600	5 170	5 510	3 470	4 010	2 570			3 780	2 430	7.82
	-3.0	*7 780	*7 780	*12 270	9 830	8 620	5 190	5 520	3 470					4 440	2 840	7.01
	-4.5	*12 210	*12 210	*11 850	10 100	*8 230	5 330							6 110	3 860	5.69

ZX180LCN-5G

Rating over-front Rating over-side or 360 degrees Unit : kg

Conditions	Load point height m	Load radius										At max. reach				
		1.5 m		3.0 m		4.5 m		6.0 m		7.5 m						
		Rating over-front	Rating over-side or 360 degrees	Rating over-front	Rating over-side or 360 degrees	Rating over-front	Rating over-side or 360 degrees	Rating over-front	Rating over-side or 360 degrees	Rating over-front	Rating over-side or 360 degrees	meter				
Boom 5.50 m Arm 2.26 m counterweight 3 900 kg shoe 500 mm	6.0							*5 020	3 690					*4 460	3 430	6.26
	4.5			*7 800	*7 800	*5 980	5 560	*5 300	3 600					*4 370	2 770	7.07
	3.0					*7 650	5 150	5 860	3 440					4 160	2 470	7.50
	1.5					8 810	4 800	5 670	3 270	4 090	2 400			4 010	2 350	7.60
	0 (Ground)					8 600	4 630	5 540	3 160					4 110	2 400	7.40
	-1.5			*8 960	8 540	8 570	4 610	5 510	3 130					4 560	2 640	6.88
	-3.0			*12 530	8 710	8 670	4 690							5 700	3 260	5.93
	-4.5			*9 380	9 060									*6 740	5 310	4.28
Boom 5.50 m Arm 2.71 m counterweight 3 900 kg shoe 500 mm	6.0							*4 510	3 740					*3 410	3 110	6.69
	4.5					*5 370	*5 370	*4 900	3 640					*3 370	2 560	7.45
	3.0					*7 060	5 240	*5 650	3 460	4 170	2 470			*3 490	2 290	7.86
	1.5					*8 720	4 840	5 680	3 280	4 080	2 390			3 730	2 180	7.96
	0 (Ground)			*4 890	*4 890	8 600	4 620	5 530	3 140	4 010	2 320			3 810	2 210	7.77
	-1.5	*5 200	*5 200	*8 820	8 400	8 520	4 560	5 460	3 090					4 170	2 410	7.27
	-3.0	*9 340	*9 340	*13 290	8 550	8 580	4 610	5 510	3 120					5 050	2 890	6.38
	-4.5			*10 670	8 860	*7 440	4 800							*6 680	4 290	4.90
Boom 5.50 m Arm 3.21 m counterweight 3 900 kg shoe 500 mm	6.0							*3 990	3 800					*2 800	2 720	7.29
	4.5					*5 370	*5 370	*4 440	3 690	*3 870	2 560			*2 750	2 290	7.99
	3.0					*7 060	5 240	*5 650	3 460	4 190	2 480			*2 830	2 070	8.37
	1.5					*8 720	4 920	5 710	3 300	4 080	2 380			*3 010	1 980	8.47
	0 (Ground)			*5 230	*5 230	8 620	4 630	5 530	3 140	3 990	2 300			*3 360	1 990	8.29
	-1.5	*4 510	*4 510	*7 970	*7 970	8 480	4 520	5 430	3 050	3 950	2 260			3 720	2 140	7.82
	-3.0	*7 780	*7 780	*12 270	8 400	8 500	4 530	5 430	3 050					4 370	2 510	7.01
	-4.5	*12 210	*12 210	*11 850	8 660	*8 230	4 670							6 030	3 410	5.69

EQUIPMENT

Standard and optional equipment may vary by country, so please consult your Hitachi dealer for details.

● : Standard equipment ○ : Optional equipment

	ZX180LC-5G	ZX180LCN-5G
ENGINE		
Air cleaner double filters	●	●
Auto idle system	●	●
Cartridge-type engine oil filter	●	●
Cartridge-type fuel pre-filter	●	●
Cartridge-type fuel main filter	●	●
Dry-type air filter with evacuator valve (with air filter restriction indicator)	●	●
ECO/PWR mode control	●	●
Engine warm-up device	●	●
Fan guard	●	●
Water separator	●	●
Pre-cleaner	○	○
Dust-Proof indoor net	●	●
Radiator reserve tank	●	●
50 A alternator	●	●
HYDRAULIC SYSTEM		
Auto power lift	●	●
Control valve with main relief valve	●	●
Full-flow filter	●	●
High mesh full flow filter with restriction indicator	○	○
Pilot filter	●	●
Power boost	●	●
Suction filter	●	●
One extra port for control valve	●	●
Work mode selector	●	●

	ZX180LC-5G	ZX180LCN-5G
CAB		
All-weather sound suppressed steel cab	●	●
AM-FM radio with 2 speaker	●	●
Ashtray	●	●
Auto control air conditioner	●	●
AUX. terminal and storage	○	○
Cab (Center pillar reinforced structure)	●	●
Drink holder	●	●
Drink holder with hot & cool	●	●
Electric double horn	●	●
Engine shut-off lever	●	●
Evacuation hammer	●	●
Fire extinguisher bracket	○	○
Floor mat	●	●
Footrest	●	●
Front window washer	●	●
Front windows on upper, lower and left side can be opened	●	●
Lower cab front guard	○	○
Upper cab front guard	○	○
Glove compartment	●	●
Hot & cool box	●	●
Intermittent windshield wipers	●	●
Key cylinder light	●	●
LED room light with door courtesy	●	●
OPG top guard Level I (ISO10262) compliant cab	●	●
Pilot control shut-off lever	●	●
Rear tray	●	●
Retractable seat belt	●	●
ROPS (ISO12117-2 : 2008) compliant cab	○	○
Rubber radio antenna	●	●
Seat : mechanical suspension seat	○	○
Seat : air suspension seat with heater	○	○
Seat adjustment part : backrest, armrest, height and angle, slide forward / back	●	●
Short wrist control levers	●	●
4 fluid-filled elastic mounts	●	●
24V cigarette lighter	●	●

	ZX180LC-5G	ZX180LCN-5G
MONITOR SYSTEM		
Alarm buzzers: overheat, engine oil pressure	●	●
Alarms: overheat, engine warning, engine oil pressure, alternator, minimum fuel level, hydraulic filter restriction, air filter restriction, etc	●	●
Display of meters: coolant temperature, hour, clock	●	●
Other displays: work mode, auto-idle, glow, rearview monitor, operating conditions, etc	●	●
32 languages selection	●	●
LIGHTS		
Additional cab roof front lights	○	○
Additional boom light	○	○
2 working lights	●	●
UPPER STRUCTURE		
Electric fuel refilling pump	○	○
Fuel level float	●	●
Hydraulic oil level gauge	●	●
Rear view camera	○	○
Rear view mirror (right & left side)	●	●
Swing parking brake	●	●
Tool box	●	●
Undercover	●	●
6.0 mm reinforced undercover	○	○
Utility space	●	●
3 900 kg counterweight	●	●
2 x 55 Ah batteries	●	●

	ZX180LC-5G	ZX180LCN-5G
UNDERCARRIAGE		
Bolt-on sprocket	●	●
Reinforced track links with pin seals	●	●
Travel motor covers	●	●
Travel parking brake	●	●
9.0 mm reinforced track undercover	○	○
Upper and lower rollers	●	●
1 track guard (each side) and hydraulic track adjuster	●	●
2 track guards (each side) and hydraulic track adjuster	○	○
4 tie down hooks	●	●
500 mm triple grouser shoes	—	●
600 mm triple grouser shoes	●	○

	ZX180LC-5G	ZX180LCN-5G
FRONT ATTACHMENTS		
Centralized lubrication system	●	●
Dirt seal on all bucket pins	●	●
Flanged pin	●	●
HN bushing	●	●
Reinforced resin thrust plate	●	●
WC (tungsten-carbide) thermal spraying	●	●
0.70 m ³ bucket (ISO heaped)	●	●
2.71 m arm	●	●
5.50 m boom	●	●

	ZX180LC-5G	ZX180LCN-5G
ATTACHMENTS		
Attachment basic piping	○	○
Breaker and crusher piping	○	○
High mesh full flow filter with restriction indicator	○	○
Parts for breaker and crusher	○	○
2 pump combined flow for attachment basic piping	○	○

	ZX180LC-5G	ZX180LCN-5G
MISCELLANEOUS		
Lockable fuel refilling cap	●	●
Lockable machine covers	●	●
Onboard information controller	●	●
Skid-resistant tapes, plates and handrails	●	●
Standard tool kit	●	●
Travel direction mark on track frame	●	●
Global e-Service	●	●



Built on the foundation of superb technological capabilities, Hitachi Construction Machinery is committed to providing leading-edge solutions and services to contribute as a reliable partner to the business of customers worldwide.

Hitachi Environmental Vision 2025

The Hitachi Group released the Environmental Vision 2025 to curb annual carbon dioxide emissions. The Group is committed to global production while reducing environmental impact in life cycles of all products, and realizing a sustainable society by tackling three goals — prevention of global warming, conservation of resources, and preservation of ecosystem.

Reducing Environmental Impact by New ZAXIS

Hitachi makes a green way to cut carbon emissions for global warming prevention according to LCA*. New ZAXIS utilizes lots of technological advances, including the new ECO mode, and Isochronous Control. Hitachi has long been committed to recycling of components, such as aluminum parts in radiators and oil cooler. Resin parts are marked for recycling.

*Life Cycle Assessment – ISO 14040

Before using a machine with a satellite communication system, please make sure that the satellite communication system complies with local regulations, safety standards and legal requirements. If not so, please make modifications accordingly.

These specifications are subject to change without notice. Illustrations and photos show the standard models, and may or may not include optional equipment, accessories, and all standard equipment with some differences in color and features. Before use, read and understand the Operator's Manual for proper operation.